

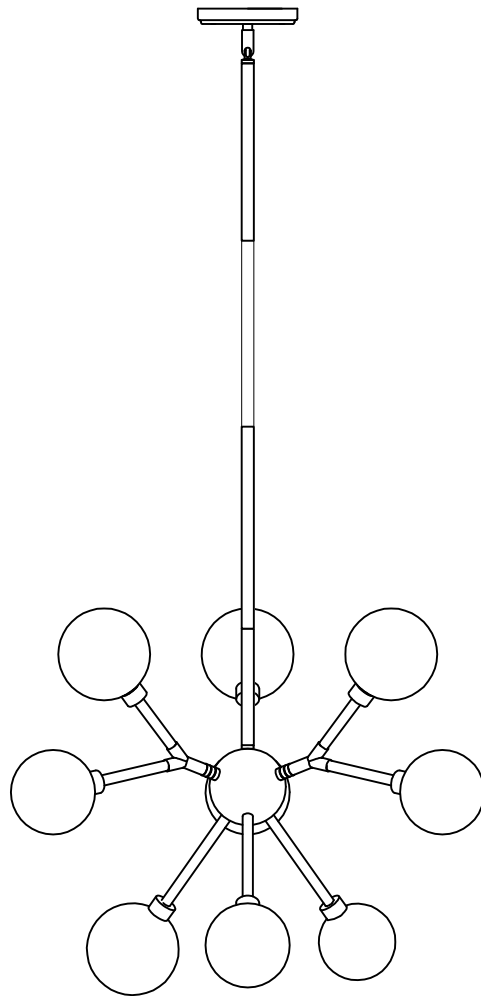

C o n t e m p o r a r y
L i g h t i n g

PRODUCT NAME: Astroid 9LT chandelier
NUMBER: E24822-138PC

Please consult your electrician for Hang fixture and wiring.



Bulb(included) :9*G9 LED 4W

MADE IN CHINA

Page 1 of (3)

IMPORTANT: Turn off power at the main fuse or circuit breaker box before starting installation

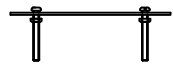

(A) Bracket



(B) Ball nut

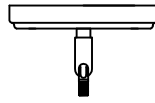

(C) Canopy

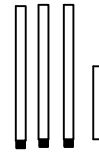

(D) Stems

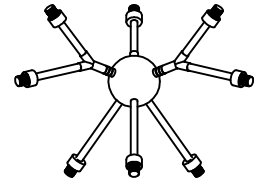

(E) Body

Locate all hardware & components before discarding packaging

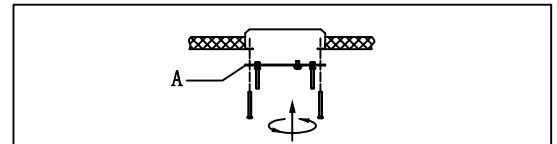
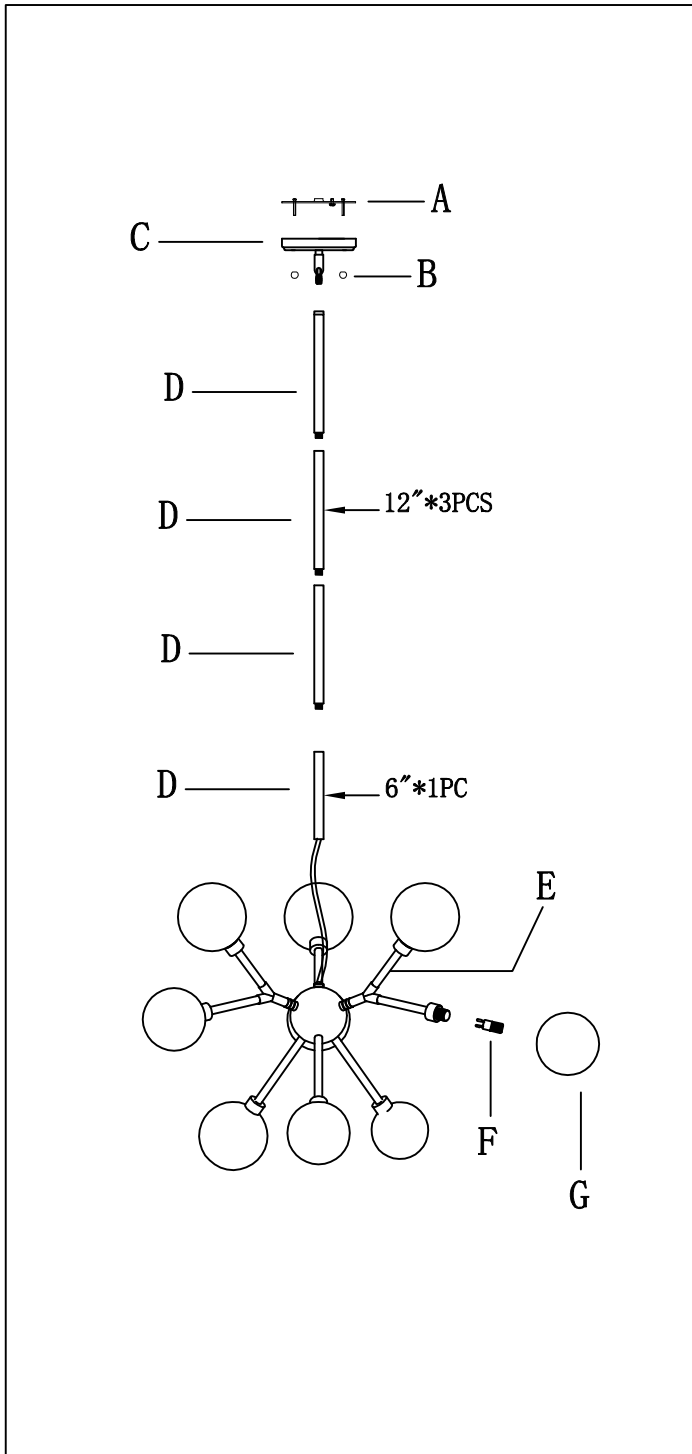

1.)

Step. 1: Remove mounting bracket (A) from fixture and install to electrical box.

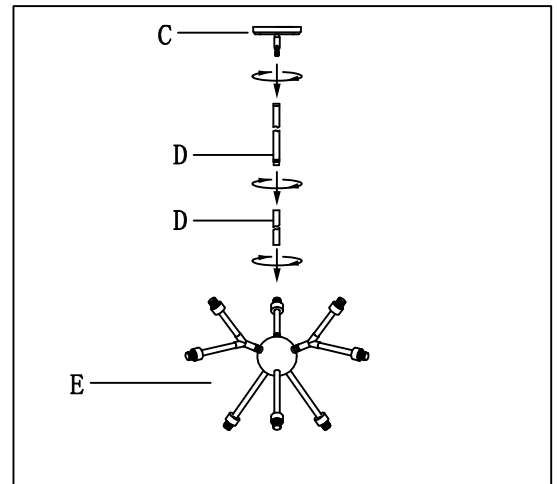

2.)

Step. 2: Run wire through stems (D) and combine stem lengths to meet desired mounting height.

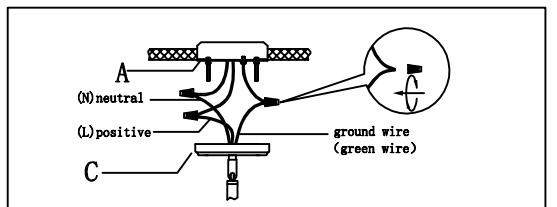

3.)

Step. 3: Wire fixture to wires in outlet box. Copper/Green wire is for Ground.

Cleaning & Care:

Clean with soft cloth and a mild detergent.
Do not use abrasive cleaner.

IMPORTANT: Turn off power at the main fuse or circuit breaker box before starting installation



(F) G9 Led Bulb



(G1) Small size glass shade- 3pcs



(G2) Middle size glass shade- 3pcs

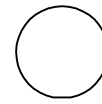

(G3) Large size glass shade- 3pcs

Locate all hardware & components before discarding packaging

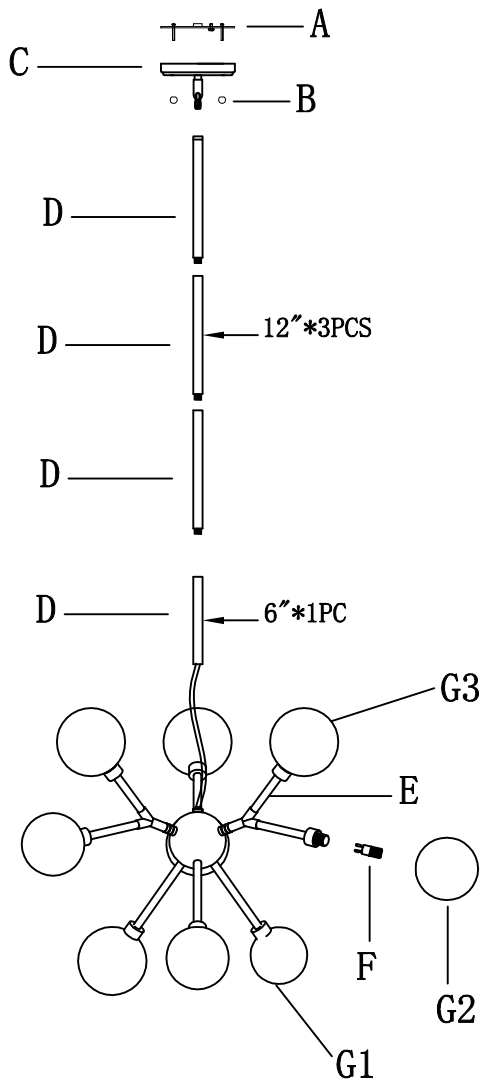

- (G1) Small size glass shade: Dia=3.94"
- (G2) Middle size glass shade: Dia=4.33"
- (G3) Large size glass shade: Dia=4.73"

4.)

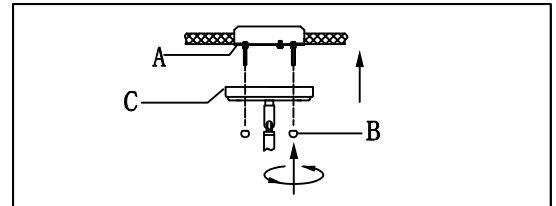

Step. 4: Install fixture to bracket and tighten ball nuts (B) on the canopy to secure.

5.)

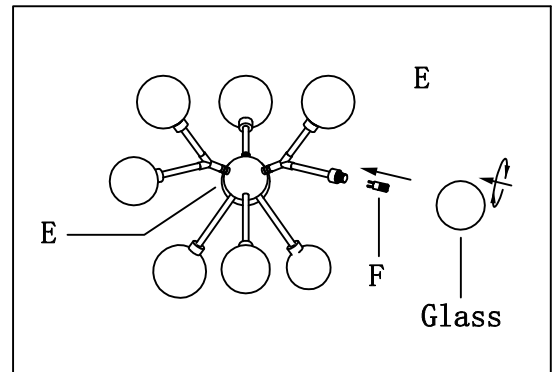

Step. 5: Instal the G9 led bulb (F), then screw G3 on the top layer, screw G2 on the middle layer, and screw G1 on the bottom layer, Or screw the three different size of glass shades (G1, G2, G3) into socket to your own idear.

Cleaning & Care:

Clean with soft cloth and a mild detergent.
Do not use abrasive cleaner.